

SOCKETS FOR TO-3 CASE

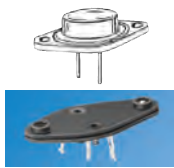

VARIOUS MOLDED BOSS HEIGHTS

MATERIAL:

Base: Phenolic, Grade PBE, Type XP
Contacts: Brass, Tin Plate
Top Plate: Nylon, ASTM-D4066
 Phenolic, Grade PBE, Type XP (Cat. No. 4606 only)
Collector Plate: Steel, Tin Plate

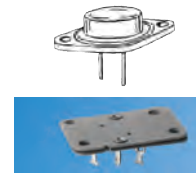

Socket and transistor are assembled to chassis at same time, using the minimum amount of hardware. Top molded boss ensure the transistor leads will be isolated from the chassis. Various boss heights available to accommodate different chassis thicknesses.

Socket is installed onto chassis using eyelets or screws. Transistor is installed afterwards. Assembly and repairs are simplified since socket will stay in place without transistor mounted. Top molded boss or added bushing ensure the transistor leads will be isolated from the chassis. Various boss heights available to accommodate standard chassis thicknesses. Use Cat. No. 4606 and nylon bushings for special chassis thicknesses.

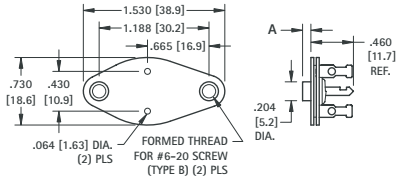

CAT. NO.	A DIM.
4603	.030 (.76)
4602	.045 (1.14)
4601	.090 (2.29)

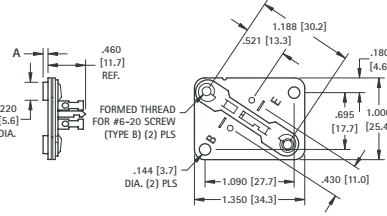

CAT. NO.	A DIM.
4606	NONE
4607	.030 (.76)
4608	.045 (1.14)
4609	.060 (1.52)
4618	.125 (3.2)

FULLY MOLDED TO-3 SOCKET



Pre-assembling the socket to the chassis by eyelets or rivets permits the installation of the semiconductor at a later stage in the assembly. The molded top boss eliminates hardware.

MATERIAL:

Base: Molded Nylon 6/6
Contacts: Brass, Tin Plate
Collector Plate: Steel, Tin Plate

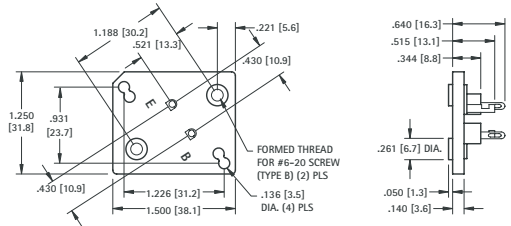

CAT. NO. 4620

HEAVY DUTY SOCKET FOR TO-3 CASE

CHOICE OF SINGLE OR DUAL COLLECTOR SOLDER TABS

Features an all-in-one mounting plate and solder tabs, providing complete electrical isolation of the solder tab connections. Rated 5 Amps DC continuous and 15 Amps DC Intermittent

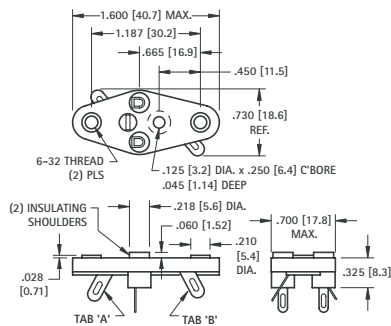

MATERIAL:

Base: Glass Filled Polyester, UL Rated 94V-0
Contacts: Brass, Tin Plate
Collector Plate: Brass, Tin Plate

With transistor lead-in insulating shoulders

CAT. NO.	WITH TAB
4513	"A" ONLY
4514	"A" & "B"

Less transistor lead-in insulating shoulders

CAT. NO.	WITH TAB
4515	"A" ONLY
4516	"A" & "B"

TO-3 CASE MOUNTING KITS

These socket kits provide everything needed to mount a transistor onto a chassis in one kit. Nylon bushings or boss will insulate transistor leads from chassis. Mica insulator isolates transistor from chassis. Two 6-20 screws included to mount transistor. (Transistor not included)

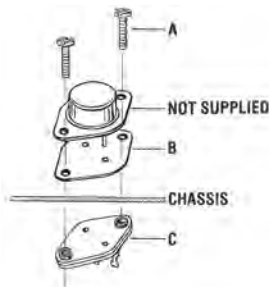

CAT. NO. 4732 Complete Mounting Kit			
ITEM	CAT. NO.	DESCRIPTION	QUANTITY
A	4706	6-20 screws	2
B	4651	Mica Insulator	1
C	4602	Socket	1

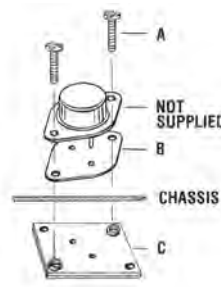

CAT. NO. 4733 Complete Mounting Kit			
ITEM	CAT. NO.	DESCRIPTION	QUANTITY
A	4706	6-20 screws	2
B	4651	Mica Insulator	1
C	4608	Square Socket	1

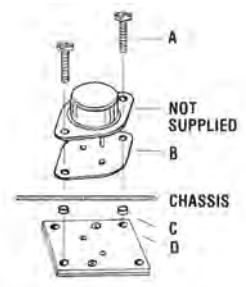

CAT. NO. 4734 Complete Mounting Kit			
ITEM	CAT. NO.	DESCRIPTION	QUANTITY
A	4706	6-20 screws	2
B	4651	Mica Insulator	1
C	4684	Nylon Bushing	4
D	4606	Square Socket	1

SOCKETS FOR TO-5 & TO-100



Fully molded compact construction. Speeds transistor assembly. Incorporates ultra high quality, closed entry, sleeve type contacts. Accepts .016 (.41) to .020 (.51) diameter leads or .010 (.25) x .018 (.46) rectangular transistor leads.

MATERIAL:
Insulator: Glass Filled Polyester, UL Rated 94V-0
Contact Pin: Brass, Tin Plate
Contact Spring: Beryllium Copper, .000030 min. Gold Plate

CAT. NO.	FOR	PINS
4590	TO-5	3
4591	TO-5	4
4592	TO-5	8
4593	TO-100	8
4594	TO-100	10

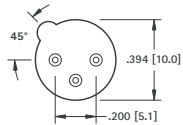

Cat. No. 4590

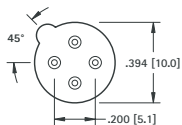

Cat. No. 4591

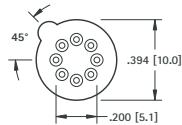

Cat. No. 4592

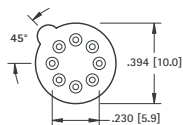

Cat. No. 4593

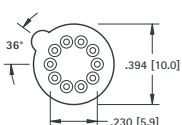

Cat. No. 4594

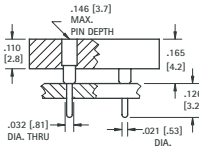

POWER TRANSISTOR MOUNTS

Molded barrier insulators functionally replaces up to six pieces of conventional insulation required with previous methods of mounting power transistors. Built-in barrier eliminates need for sleeving of connections.

NOTE: #6-20 mounting screw available **CAT. NO. 4706**

For TO-3 CASES

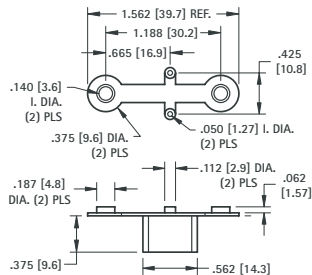

MATERIAL: Nylon 6/6, UL Rated 94V-2

CAT. NO. 4616

HEAVY DUTY TO-3

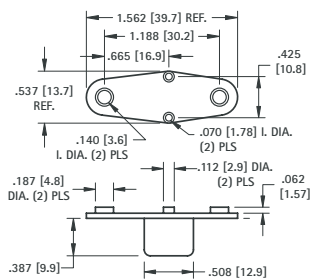

MATERIAL: Glass filled Polyester, UL Rated 94V-0

CAT. NO. 4626

For TO-66 CASES

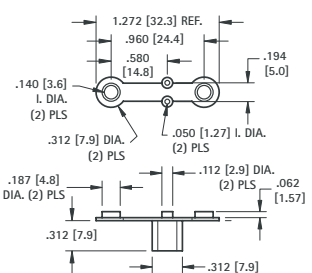

MATERIAL: Nylon 6/6, UL Rated 94V-2

CAT. NO. 4617

"MINI" HALOGEN LAMP SOCKETS

- Accepts .022 (.032) to .032 (.81) diameter Pins or Leads
- The Wire Wrap Pins can be easily bent to achieve a variety of positions

SPECIFICATIONS

Base: Glass Filled LCP; **Contact:** Beryllium Copper, Gold Plate; **Shell:** Brass, Nickel Plate

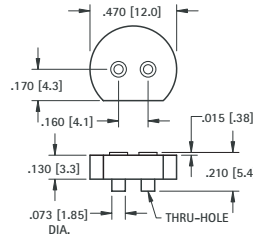
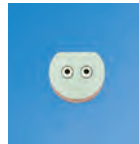

CAT. NO. 4595

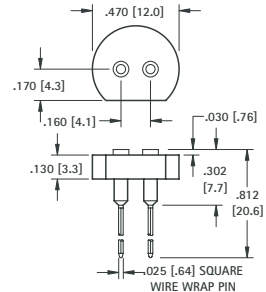

CAT. NO. 4596

TO-3 SOCKET FOR PC BOARDS



Easily assembles onto printed circuit board. Eliminates wiring. Stops on PC terminals provide sufficient spacing between socket and PC board to permit proper assembly of transistor to socket. Can be screwed down tightly to heat sink.

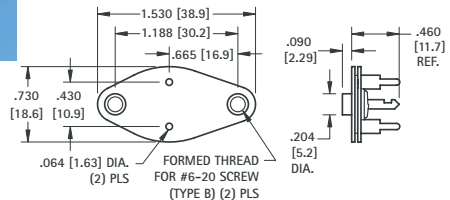

Bottom View Mounting Detail

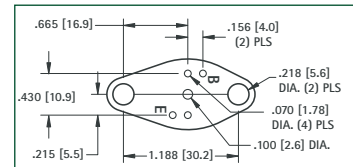

MATERIAL:

Top Plate: Molded Nylon
Base: Phenolic
Contacts: Brass, Tin Plate
Collector Plate: Steel, Tin Plate

CAT. NO. 4600

NYLON TO-3 CASE COVERS

Molded nylon covers easily mount over and insulate the power transistor. Will withstand temperatures to approximately 250°F (107°C).

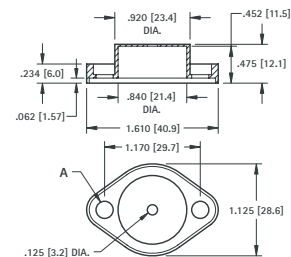

MATERIAL: Nylon 6/6, UL Rated 94V-2

CAT. NO.	FOR	EYELETS INSTALLED	A
4632	TO-3	NONE	.210 (5.4)
4634	TO-3	TWO	.140 (3.6)